

# WEDHOLMS AB ELDOKUMENTATION ELECTRIC DOCUMENTATION

APPARATMONTAGE A1 EnL.319871 (EQUIPMENT A1)  
 APPARATLISTA A1 EnL.319872 (EQUIPMENT LIST A1)  
 PLINTMONTAGE WINMASTER EnL.319873 (TERMINAL BLOCK WINM)  
 KRETSSCHEMA EnL.319874-319875 (CIRCUIT DIAGRAM)  
 KABELLISTA EnL.319876 (CABLE LIST)  
 YTTRE FÖRBINDNING EnL.319877-319879 (EXTERNAL CONNECTION)  
 SKARVLÅDA DF95 EnL.319880 (CONNECTION-BOX DF95)

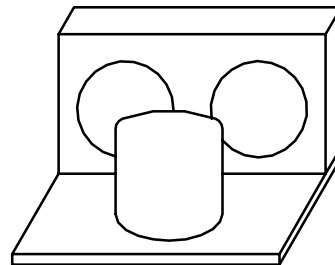

Ritad	Datum	Godk.	Stand.gr.	Skala	Sammanst.r./tn.nr
tba	03-01-10	mjh		.	.
Box2003 för WinMaster					Örden nr
Box2003 for WinMaster					.
WinMaster 1comp+Base K,L,M,N or P					Ersätter
					Ersatt av
<b>Wedholms</b>		Ref.nr	Utgåva	Ritn.Nr	
Wedholms AB		.	A	319870	

A1

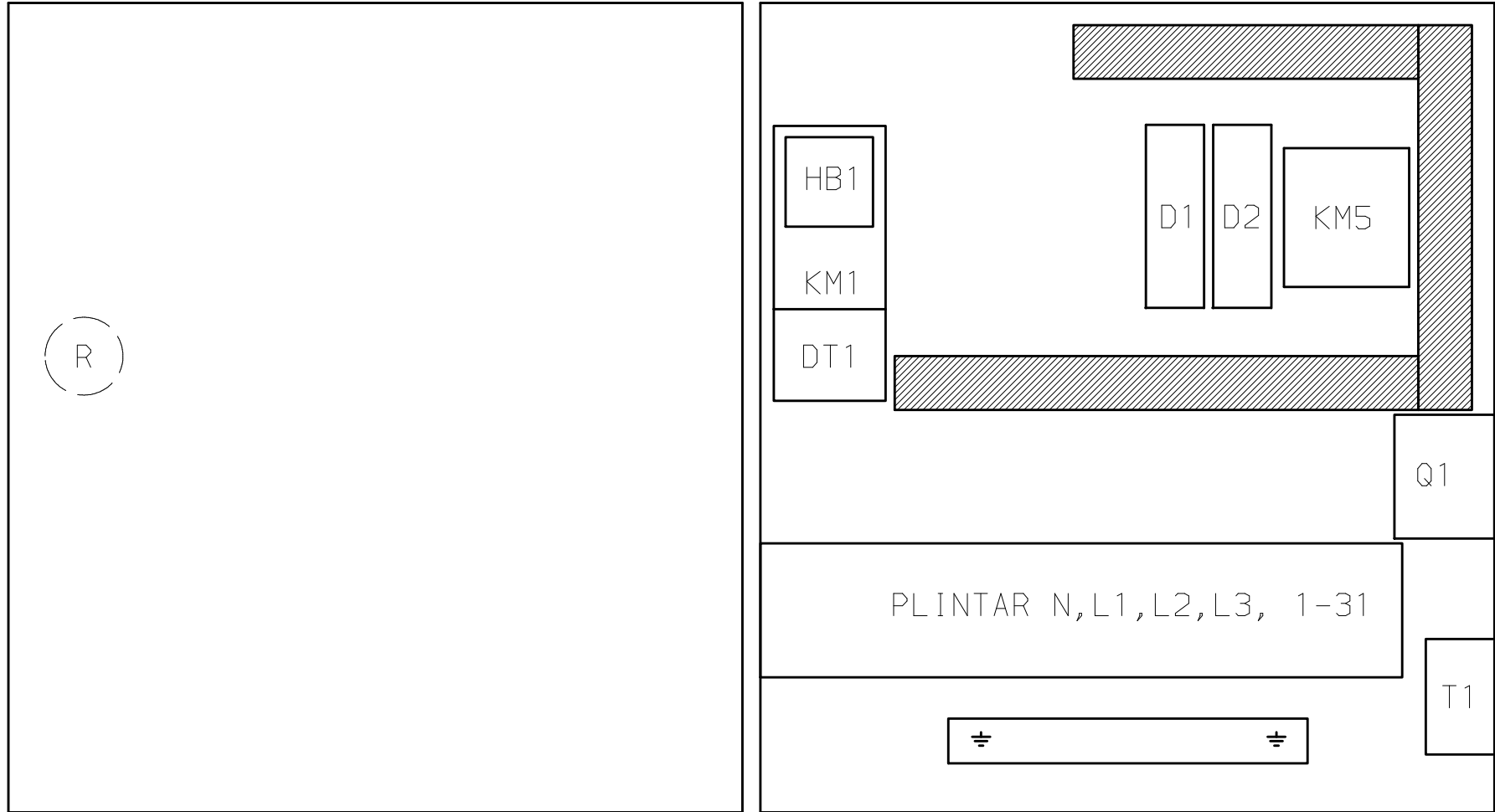

Ritad	Datum	Godk.	Stand. gr.	Skala	Sammanst. ritn. nr
LON	16-10-18	AH		.	.
Box2003 för WinMaster					Order nr
Box2003 for WinMaster					.
Apparatmontage A1/Equipment A1					Ersätter
					Ersatt av
<b>Wedholms</b>					Ritn. Nr
Wedholms AB					C
					319871

ANTAL	POST	BETECKNING	FABRIKAT	ANMÄRKNING	REV.
1	DT 1	LRD 14 or LRD 21 or LRD22	SCHNEIDER	ÖVERSTRÖMSRELÄ 7-10A (12-18A) (16-24A) (BREAKER COMPRESSOR)	
1	R	XB5 AA86102	SCHNEIDER	ÅTERSTÄLLNING ÖVERSTRÖMSRELÄ / RESET OVER CURRENT	
1	KM 1	LC1 D18 or (LC1 D25)	SCHNEIDER	KONTAKTOR (CONTACTOR COMPRESSOR)	
1	KM 5	LC1K K0910 M72	SCHNEIDER	MINI KONTAKTOR (CONTACTOR CLEANING PUMP)	
1	D1	DT40 C10	SCHNEIDER	AUTOMATSÄKRING 2 POL (BREAKER FANS/CLEANING PUMP)	
1	D2	DT40 C6	SCHNEIDER	AUTOMATSÄKRING 2 POL (BREAKER CONTROL/WINMASTER)	
1	T1	T85 TYP600	DIEHL	TIDUR (TIMER)	
1	HB1	LADN20	SCHNEIDER	HJÄLPBLOCK (AUXILIARY BLOCK)	
1	Q1	PSA032 AK341E	EMAS	HUVUDBRYTARE (MAIN SWITCH)	

Ritad	Datum	Godk.	Stand. gr.	Skala	Sammanst. ritn. nr.
LÖN	16-10-18	AH		.	.
Box2003 för WinMaster					Örden nr.
Box2003 for WinMaster					.
Apparatlista A1/Equipment list A1					Ersätter
Ersatt av					.
<b>Wedholms</b>				Ref. nr.	Ritn. nr.
Wedholms AB				Utgåva	319872
				C	.

Demonteras vid  
montering av värmare

# Box-WinMaster

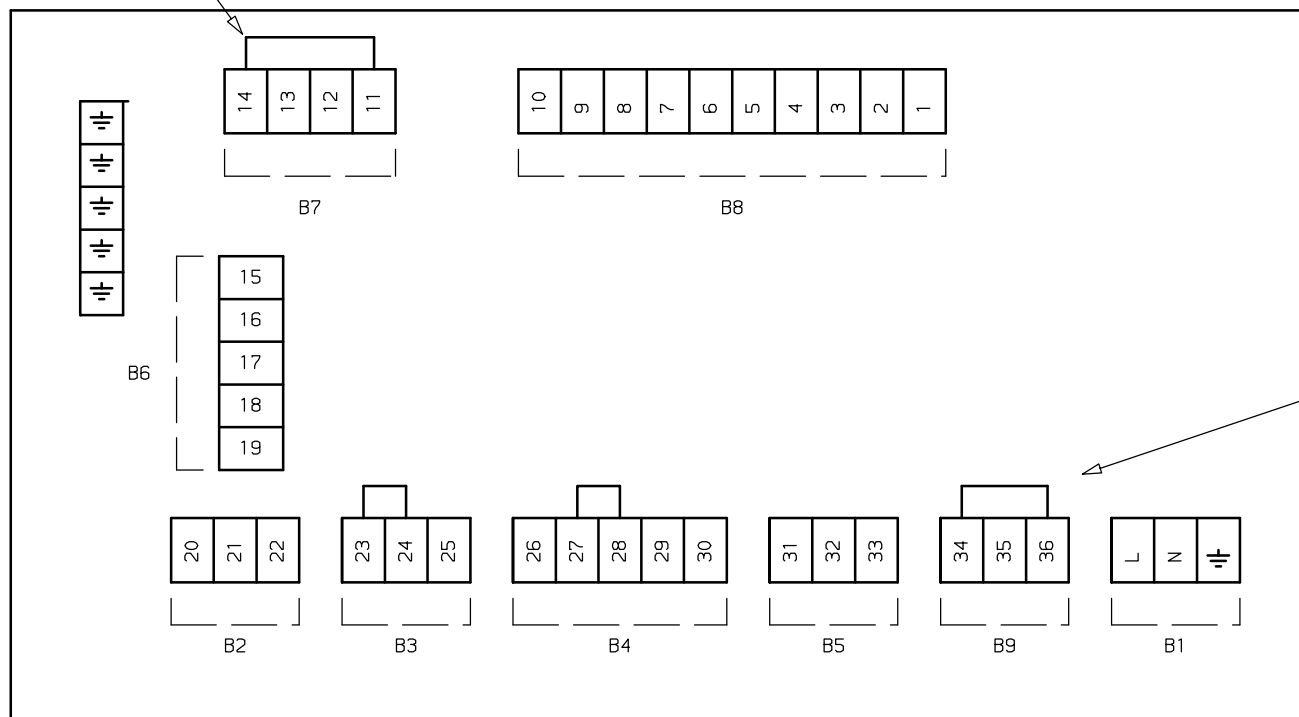

Demonteras vid  
robotanslutning

ANSLUTNINGSPLINTAR PLACERADE I BOTTENDEL  
TERMINAL BLOCK PLACED IN BOTTOM PART

Ritad	Datum	Godk.	Stand. gr.	Skala	Sammanst. ritn. nr.
tba	03-01-10	mjh		.	.
Box2003 för WinMaster					Order nr
Box2003 for WinMaster					.
Plintar box/Terminal block box					Ersätter
					Ersatt av
<b>Wedholms</b> Wedholms AB			Ref. nr	Utgåva	Ritn. Nr
			.	A	319873

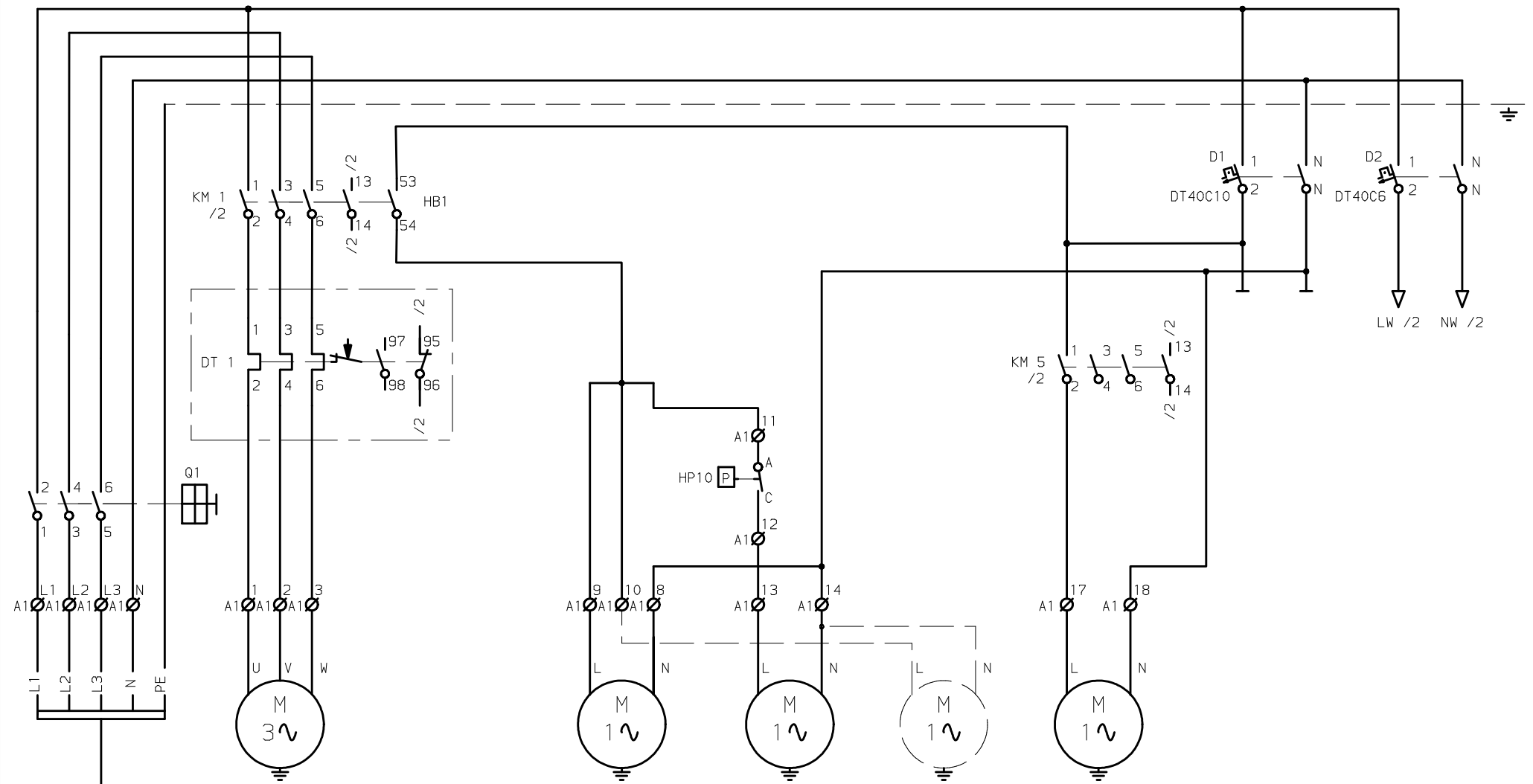

M 1  
KOMPRESSOR  
COMPRESSOR

M 10  
FLÄKT 1  
FAN 1

M 11  
FLÄKT 2  
FAN 2

MC5  
PUMP INTERPAC (OPTION)  
PUMP INTERPAC (OPTION)

M 5  
DISKPUMP  
CLEANING PUMP

FLÄKTAR OCH PUMPAR  
FANS AND PUMPS

MANÖVERSPÄNNING WINM.  
CONTROL WINMASTER

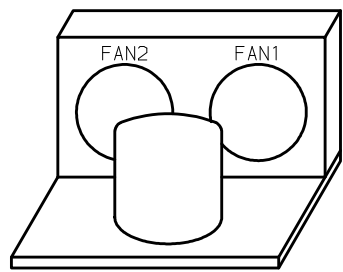

MATNING 3x400 PEN  
MAIN CABLE

Ritad LON	Datum 16-10-18	Godk. AH	Stand. gr.	Skala	Sammanst. ritn. nr.
Box2003 för WinMaster Box2003 for WinMaster Kretsschema/Circuit diagram 1 (2)					Order nr.
Ersätter					Ersatt av
 Wedholms AB				Ref. nr.	Utgåva D
					Ritn. Nr. 319874

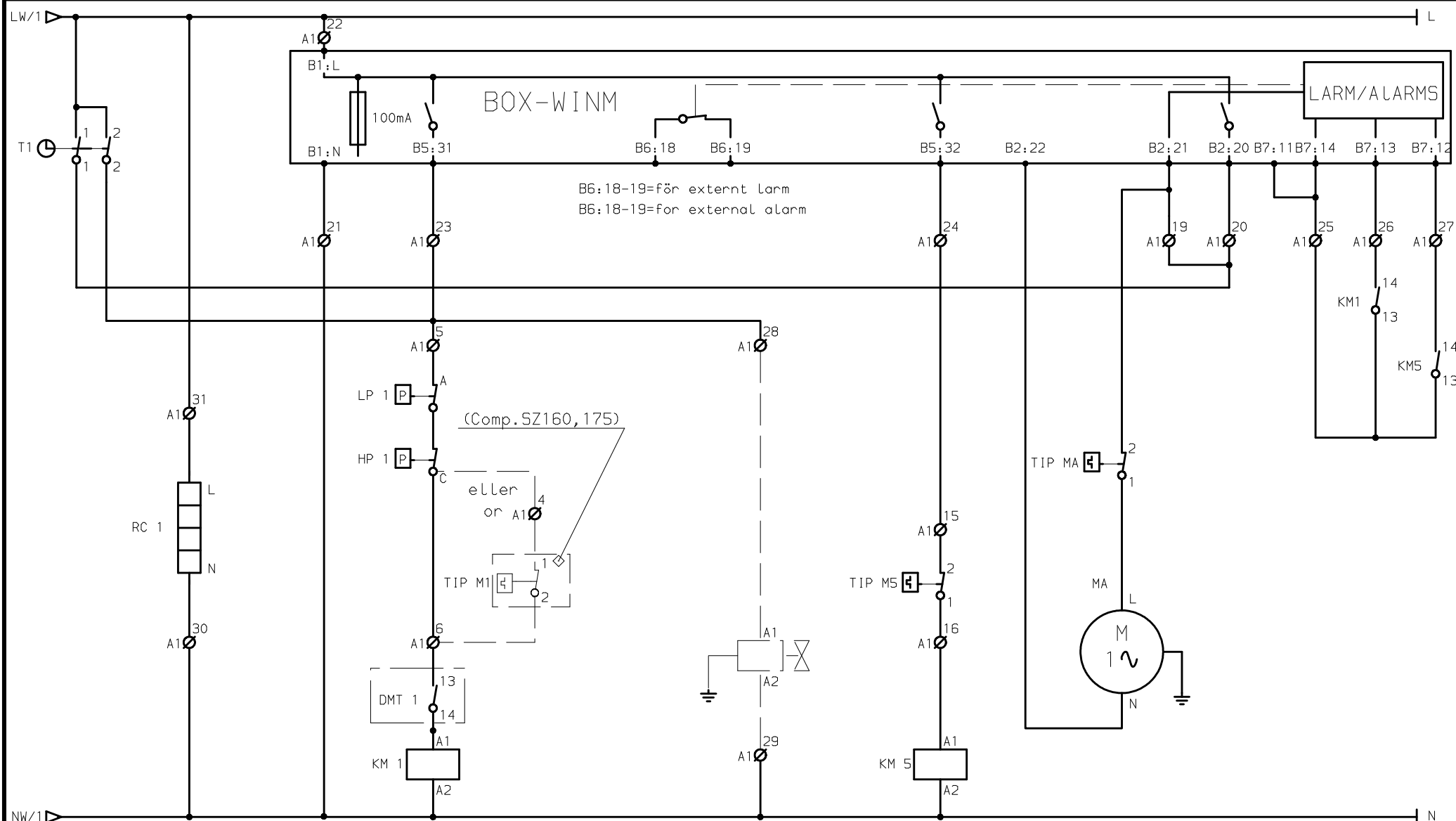

B6:18-19=för externt larm  
 B6:18-19=for external alarm

VEVHUSVÄRMARE  
 CRANKCASE HEATER

KÖMPRESSÖR  
 COMPRESSOR

MAGNETVENTIL (OPTION)  
 SOLENOID VALVE (OPTION)

DISKPUMP  
 CLEANING PUMP

RÖRVERK  
 AGITATOR

Ritad LÖN	Datum 16-03-12	Godk. AH	Stand. gr.	Skala .	Sammanst. ritn. nr.
Box2003 för WinMaster Box2003 for WinMaster Kretsschema/Circuit diagram 2 (2)					Order nr. . . Ersätter . Ersatt av .
<b>Wedholms</b> Wedholms AB			Ref. nr. .	Utgåva B	Ritn. Nr. 319875

KABEL NUMMER	ANSLUTNING A	KABELTYP, AREA	ANSLUTNING B	ANMÄRKNING	REV.
1	FÖRDELN. CENTRAL	REV 5G1.5 (5G2.5) (5G4)	A1	INKOMMANDE MATNING 3X400V P.EN 16A or 25A/MAIN CABLE	
2					
3	A1	RKK 4G2.5	M 1	KOMPRESSOR/COMPRESSOR	
4	A1	RKK 3G1	HP1/LP1	PRESSOSTATER KOMPRESSOR/SAFETY PRESSOSTAT HIGH/LOW	
5	A1	RKK 3G1	M 10	FLÄKT 1/FAN 1	
6	A1	RKK 3G1	M 11	FLÄKT 2/FAN 2	
7	A1	RKK 3G1	HP 10	PRESSOSTAT FLÄKT 1/PRESSOSTAT FAN 1	
8	(A1)	(RKK 3G1.5)	(M1)	(KOMPRESSOR TERMISKT SKYDD SZ160,175/THERMALS PROTECTION COMP.)	
9					
10	Box WinMaster	FKK 3G1.5	MA	RÖRVERK/AGITATOR	
11	A1	RKK 5G1.5	M 5	DISKPUMP MED INBYGGT TERMISKT SKYDD/CLEANING PUMP	
12	(A1)	(FKK 3G1.5)	(MC5)	(INTERPAC OPTION)	
13	A1	10G0.75	Box WinMaster	INTERFACE KABEL A1-WINMASTER/INTERFACE CABLE A1-WINMASTER	
14	A1	RKK 3G1.5	RC 1	VEVHUSVÄRMARE KOMPRESSOR/CRANKCASE HEATER COMPRESSOR	
15	(A1)	(RKK 3G1.5)	(MV1)	(MAGNETVENTIL OPTION)/SOLENOID VALVE	
20	Box WinMaster	2G0.75	SENSOR	TEMPERATUR PRODUKT/TEMPERATURE PRODUCT	
21	Box WinMaster	2G0.75	PLS	NIVÅ PRODUKT/LEVEL PRODUCT	
22	Box WinMaster	2G0.75	LD	NIVÅ PRODUKT/LEVEL PRODUCT	
23	Box WinMaster	2G0.75	MP 1	PUMP LUT/PUMP LYE	
24	Box WinMaster	2G0.75	MP 2	PUMP SYRA/PUMP ACID	
25	Box WinMaster	3G0.75	EV 6	MAGNETVENTIL DRÄNERING/SOLENOID VALVE DRAINAGE	
26	Box WinMaster	2G0.75	EV 1	MAGNETVENTIL KV SKÖLJ/SOLENOID VALVE KV RINSING	
27	Box WinMaster	2G0.75	EV 3	MAGNETVENTIL KV DIREKT/SOLENOID VALVE KV DIRECT	
28	Box WinMaster	2G0.75	EV 2	MAGNETVENTIL VV DIREKT/SOLENOID VALVE VV DIRECT	

Ritad	Datum	Godk.	Stand. gr.	Skala	Sammanst. ritn. nr.
tba	03-01-10	mjh		.	.
Box2003 för WinMaster					Örden nr.
Box2003 for WinMaster					.
Kabellista/Cable list					Ersätter
					Ersatt av
					.
<b>Wedholms</b>			Ref. nr.	Utgåva	Ritn. Nr.
Wedholms AB			.	A	319876

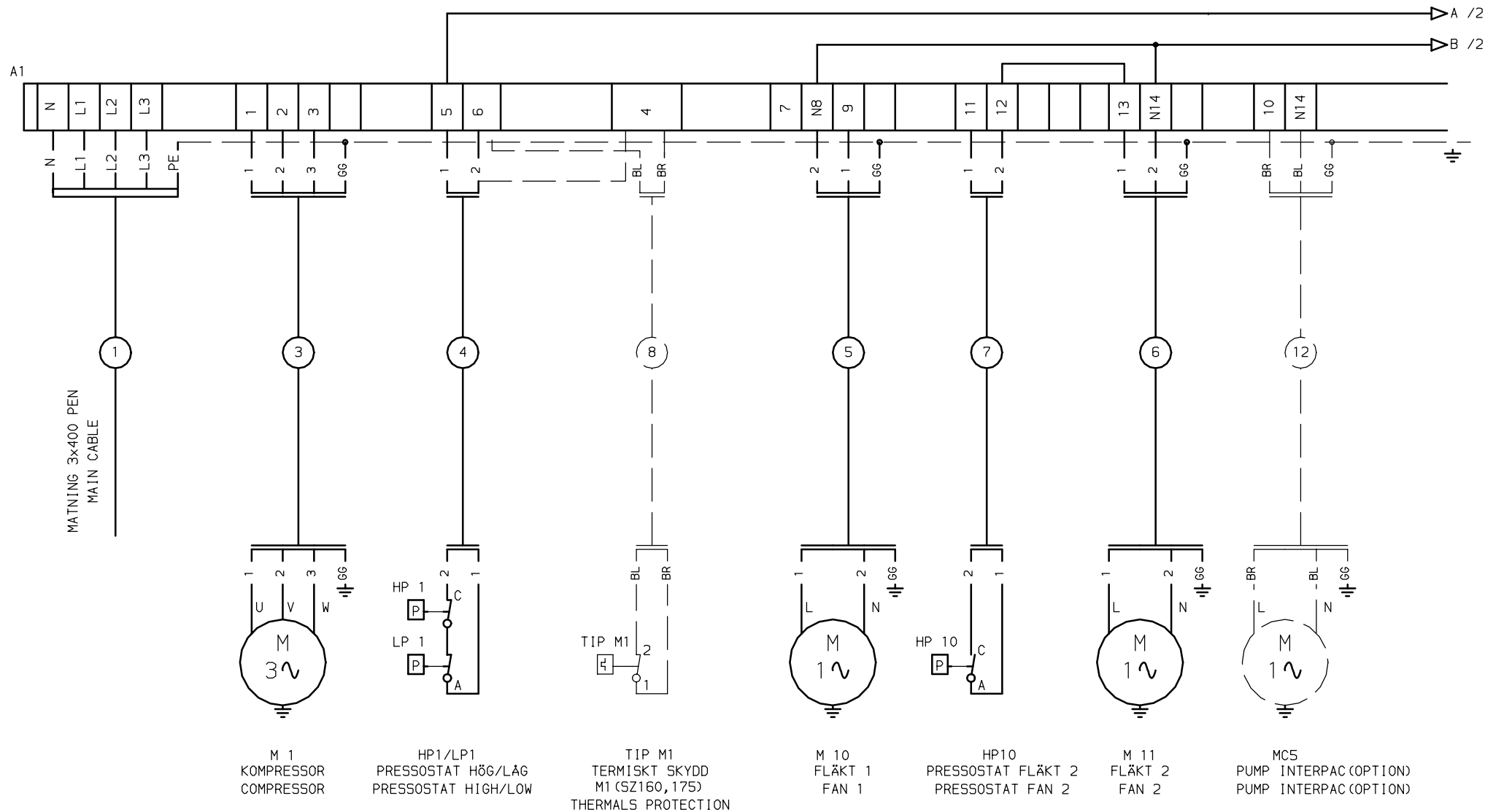

FÄRGKOD PARTER/COLOURS PARTS

- SV - SVART-BLACK
- BL - BLÅ-BLUE
- BR - BRUN-BROWN
- R - RÖD-RED
- V - VIT-WHITE
- G - GRÅ-GREY
- VI - VIOLETT-VIOLET
- RO - ROSA-PINK
- O - ORANGE-ORANGE
- GG - GUL/GRÖN-YELLOW/GREEN

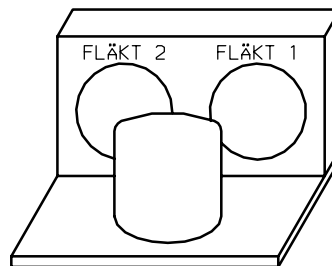

Ritad tba	Datum 03-01-10	Godk. mjh	Stand. gr.	Skala .	Sammanst. ritn. nr.
Box2003 för WinMaster Box2003 for WinMaster Yttre förbindning/Connection 1(3)					Örden nr. .
Ersätter .					Ersatt av .
<b>Wedholms</b> Wedholms AB			Ref. nr. .	Utgåva A	Ritn. Nr. 319877



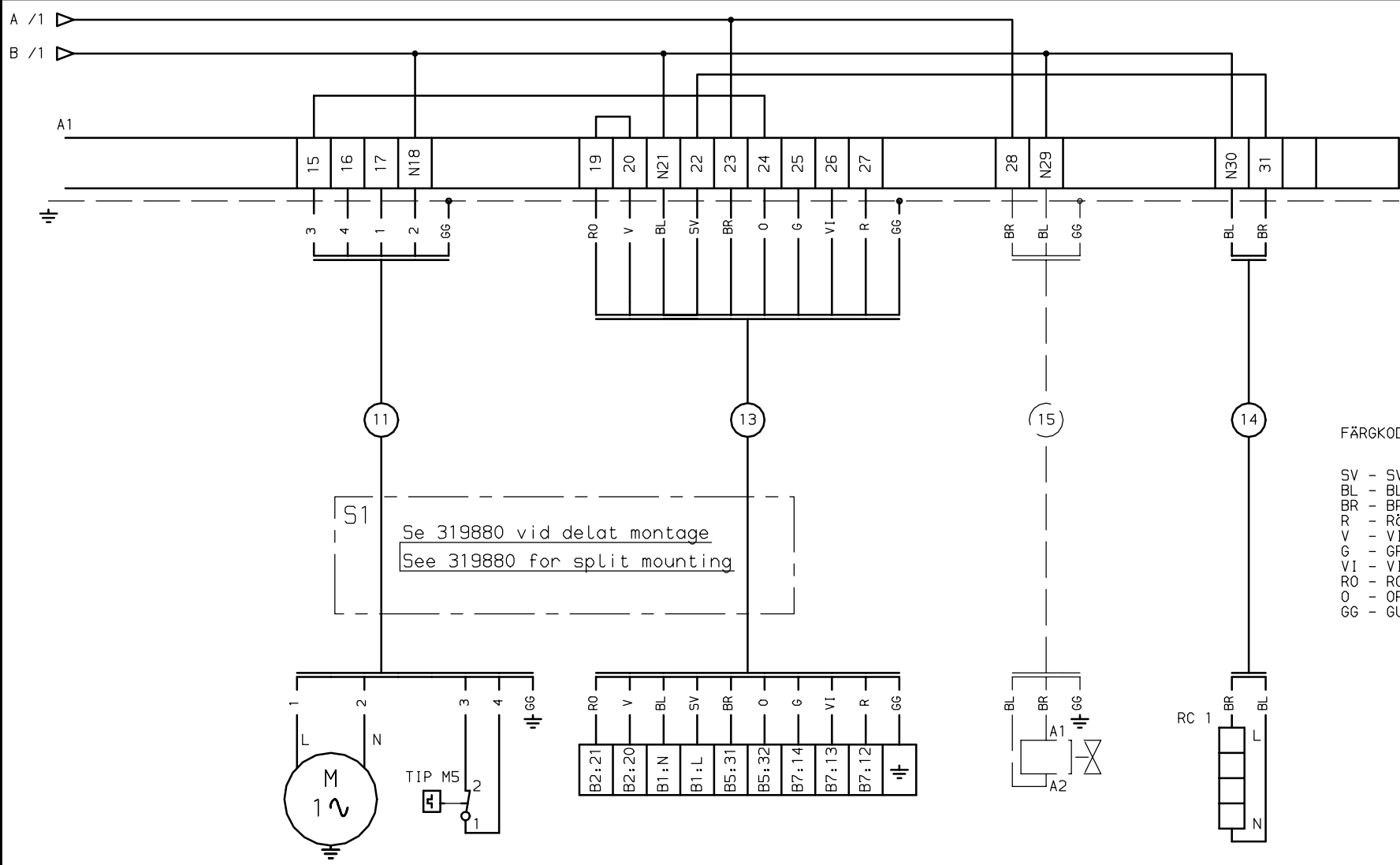

FÄRGKOD PARTER/COLOURS PARTS

- SV - SVART-BLACK
- BL - BLÅ-BLUE
- BR - BRUN-BROWN
- R - RÖD-RED
- V - VIT-WHITE
- G - GRÅ-GREY
- VI - VIOLETT-VIOLET
- RO - RÖSA-PINK
- O - ORANGE-ORANGE
- GG - GUL/GRÖN-YELLOW/GREEN

M 5  
DISKUMP  
CLEANING PUMP

TIP M5  
TERMISKT SKYDD DISKUMP  
THERMALS PROTECTION

TILL WINMASTER  
TO WINMASTER

MV1  
MAGNETVENTIL (OPTION)  
SOLENOID VALVE (OPTION)

RC1  
VEVHUSVÄRMARE  
CRANKCASE HEATER

Ritad tba	Datum 03-01-10	Godk. mjh	Stand. gr.	Skala .	Sammanst. r. i tn. nr. .
Box2003 för WinMaster Box2003 for WinMaster Yttre förbindning/Connection 2(3)					Order nr. .
Ersätter .					Ersatt av .
<b>Wedholms</b> Wedholms AB			Ref. nr. .	Utgåva A	Ritn. Nr. 319878

# BOX WINMASTER

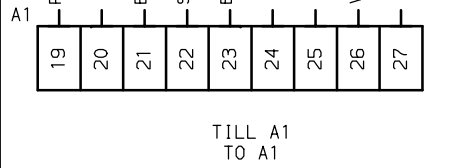
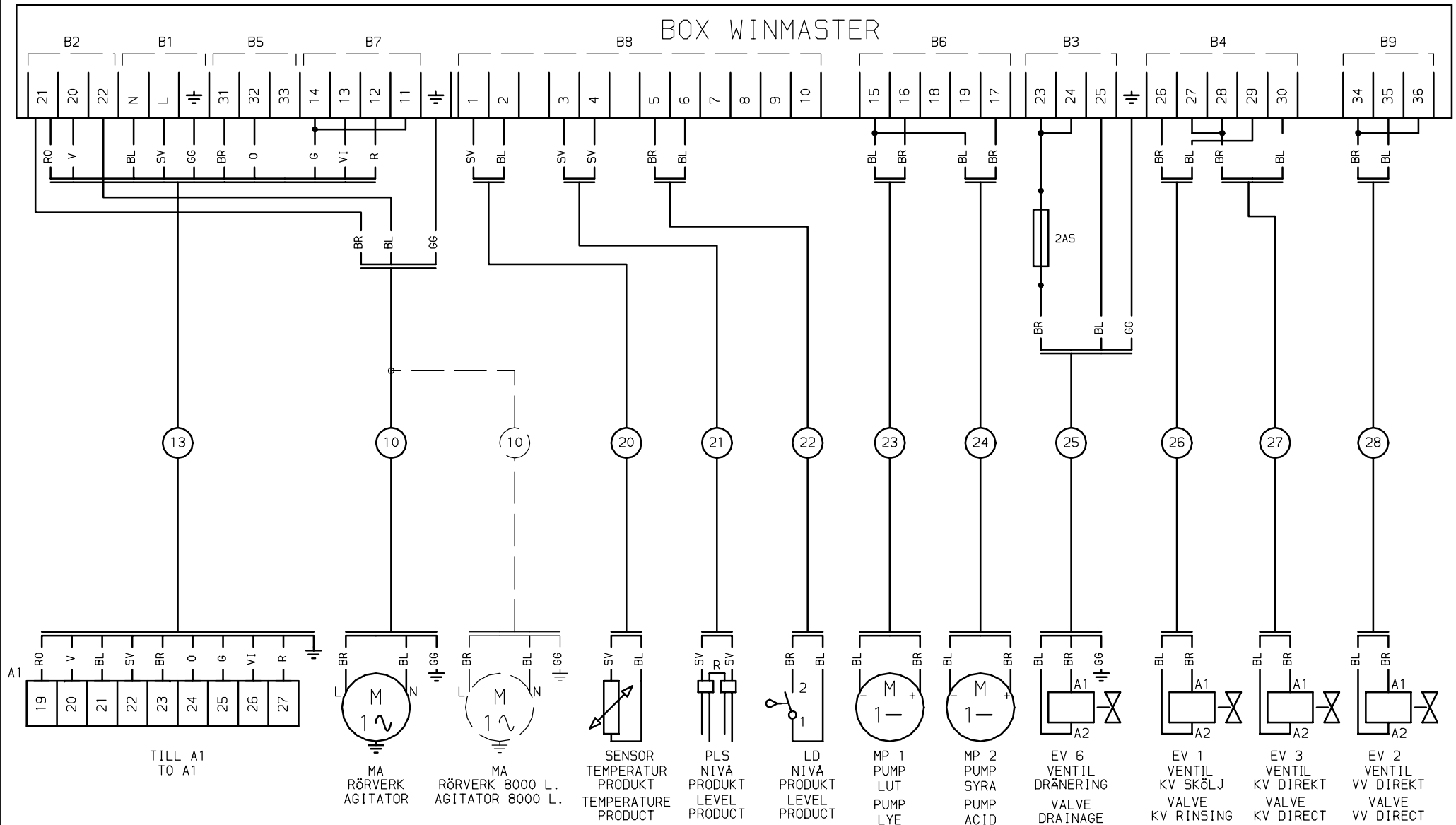

**FÄRGCOD PARTER/COLOURS PARTS**

- SV - SVART-BLACK
- BL - BLÅ-BLUE
- BR - BRUN-BROWN
- R - RÖD-RED
- V - VIT-WHITE
- G - GRÅ-GREY
- VI - VIOLETT-VIOLET
- RO - ROSA-PINK
- O - ORANGE-ORANGE
- GG - GUL/GRÖN-YELLOW/GREEN

Ritad tba	Datum 03-01-10	Godk. mjh	Stand.gr.	Skala .	Sammanst.r i t.n.nr.
Box2003 för WinMaster Box2003 for WinMaster Yttre förbindning/Connection 3(3)					Örder nr
<b>Wedholms</b> Wedholms AB					Ersätter
Ref.nr					Ersatt av
Utgåva B					319879
Ritn.Nr					

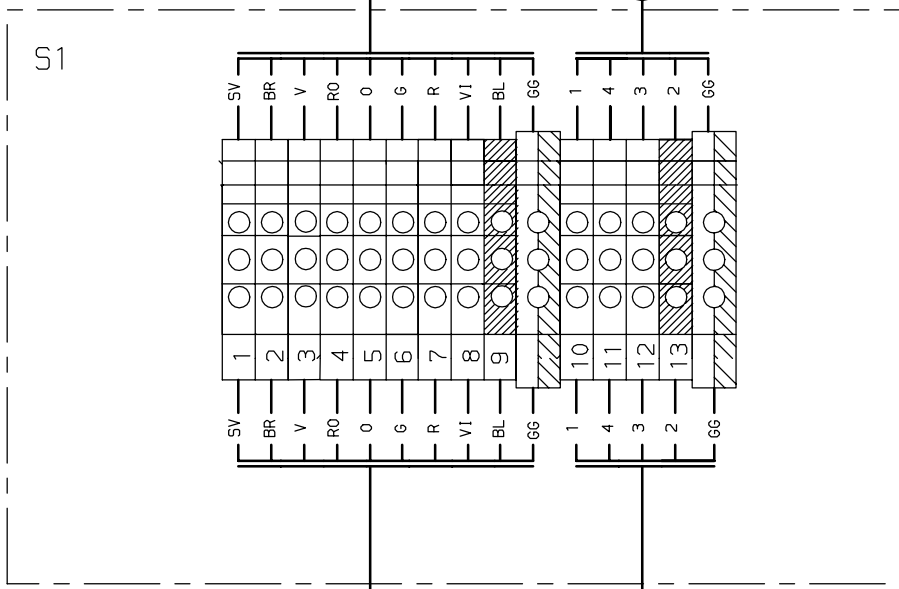
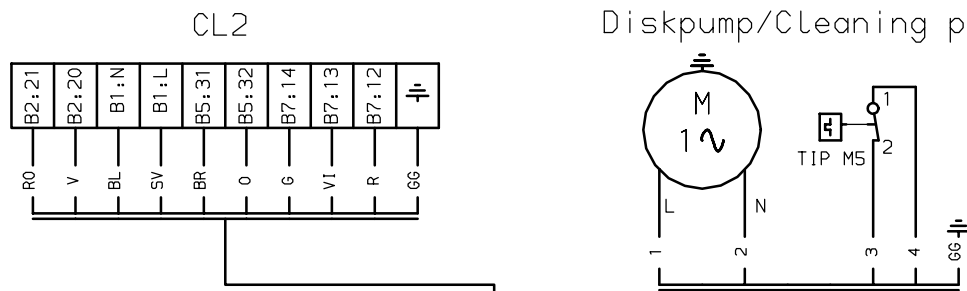

Skarvlåda S1 på bakre tankgavel  
 Connection-box S1 rear end tank

FÄRGKOD PARTER/COLOURS PARTS

- SV - SVART/BLACK
- BL - BLÅ/BLUE
- BR - BRUN/BROWN
- R - RÖD/RED
- V - VIT/WHITE
- G - GRÅ/GREY
- VI - VIOLETT/VIOLET
- RO - ROSA/PINK
- O - ORANGE/ORANGE
- GG - GUL/GRÖN--YELLOW/GREEN

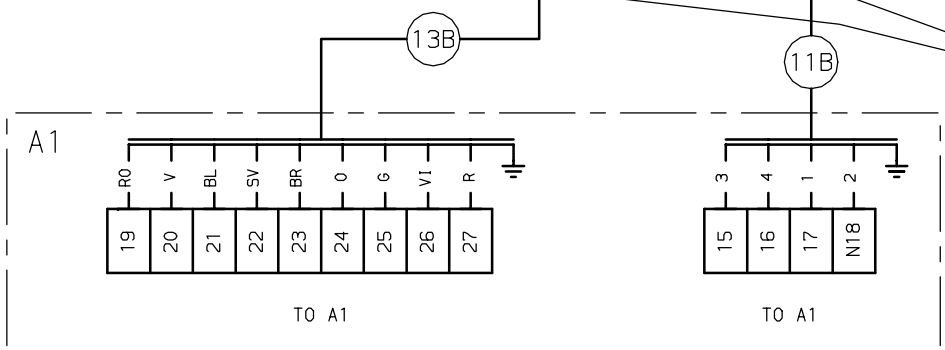

Platsmontage (medlevereras ej)  
 Not supplied by manufacturer

ELDOKUMENTATION/DOCUMENTATION  
 ENL. 319870-319880

Ritad	Datum	Godk.	Stand. gr.	Skala	Sammanst. ritn. nr.
tba	03-01-10	tba		.	.
Box2003 för WinMaster					Order nr
Box2003 for WinMaster					.
Skarvlåda DF95/Connection-box DF95					Ersätter
					Ersatt av
<b>Wedholms</b>		Ref. nr	Utgåva	Ritn. Nr	
Wedholms AB		.	B	319880	